

EURO ECO / EURO deluxe

DC 2

geba[®]
tronic

DC 2 - Control Unit
conforms to DIN EN 12453



Installation Manual

Table of contents

Security instructions and technical data	p2
DC – 2 EURO ECO	
<i>1-phase 230VAC motor and build-in-starters</i>	p3
<i>Layout</i>	p4
<i>Programming</i>	p5
<i>Optional programming radio control</i>	p6
<i>Troubleshooting</i>	p7
DC – 2 EURO deluxe	
<i>1-phase 230VAC motor and build-in-starters</i>	p3
<i>Layout</i>	p8
<i>Status display</i>	p9
<i>Programming</i>	p10-11
<i>Troubleshooting</i>	p12
Connection and Accessories for DC – 2 EURO ECO and DC – 2 EURO deluxe	
<i>Limit switches</i>	p13
<i>KDT 2 / M-Series 2T and KDT 3 push button</i>	p14
<i>M-Series 1T, emergency stop / KDT 1 and ES Series</i>	p15
<i>J Series and J Series with Stop</i>	p16
<i>LS 1 and LS 2 photo beams</i>	p17
<i>Safety-edge Pro-Sec-O</i>	p19
Connection and Accessories for DC – 2 EURO deluxe only	
<i>LS 2 and LS 3 reflector photo beams</i>	p18
<i>LS 4 Photobeam and 8k2 Ω resistor</i>	p19
<i>Signal light 230VAC and Court light 230VAC</i>	p20
<i>Cody wiring and programming</i>	p21-22
<i>Transponder wiring and programming</i>	p23-24
<i>Radio control programming</i>	p25-26

The door control DC 2 EURO is designed for hold to run control of power operated doors. The basic version is designed for hold to run operation only, and you are not allowed to use the automatic function without using additional safety devices.

- In case of using DC 2 EURO with a permanent mains connection, an all-pole main switch with an appropriate back-up fuse must be provided.
- Before operation, check whether the permissible mains voltage range of the device corresponds to the local mains voltage.
- Please note that the door control as well as the motor are for indoor installation only.
- During installation, initial operation, maintenance and testing of the DC 2 EURO it is necessary to observe the safety and accident prevention regulations valid for the specific application. Only trained electrical craftsmen should work on electrical equipment.

Appliance according to the regulations

The door control DC 2 EURO is provided for the operation of sectional-, rollershutter-, folding- and swingdoors. The manufacturer of the complete installation is responsible. He must take care that the relevant standards and guidelines (e.g. DIN 1986, EN 12050) have to be respected.

He must take care that a technical documentation of the whole installation is made available.

The technical documentation must be added to the door unit.

Installation, operating and use of the unit against this manual or the described technical specifications causes danger for persons and produces a liability- and obligations release.

National and regional precautions and standards for the installation, as well as safety precautions of local technical standards have to be respected.

Technical data		
Model	DC 2 – EURO deluxe	DC 2 – EURO ECO
Supply voltage	230VAC 4,5VA	230VAC 4,5VA
Frequency	50 Hz	50 Hz
Protection class	IP 54	IP 54
Outputs motor	3x NO relay contact 230 V / 5 A 2x NO relay contact 230 V / 2 A 1x unregulated supply voltage 24V DC, max. 50mA	3 x NO relay contact 230 V / 5 A 1x unregulated supply voltage 24V DC, max. 50mA
Wiring	1,5 mm ² max.	1,5 mm ² max.
Operating temperature	- 10 C° to + 55 C°	- 10 C° to + 55 C°

Connection

1-phase 230VAC motor

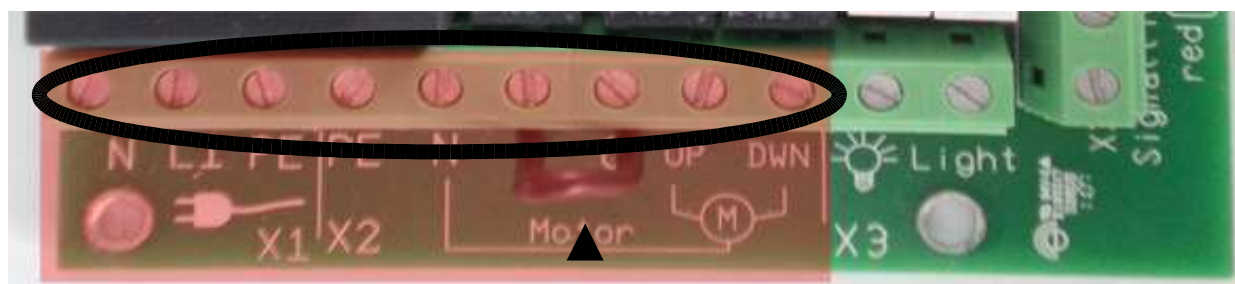
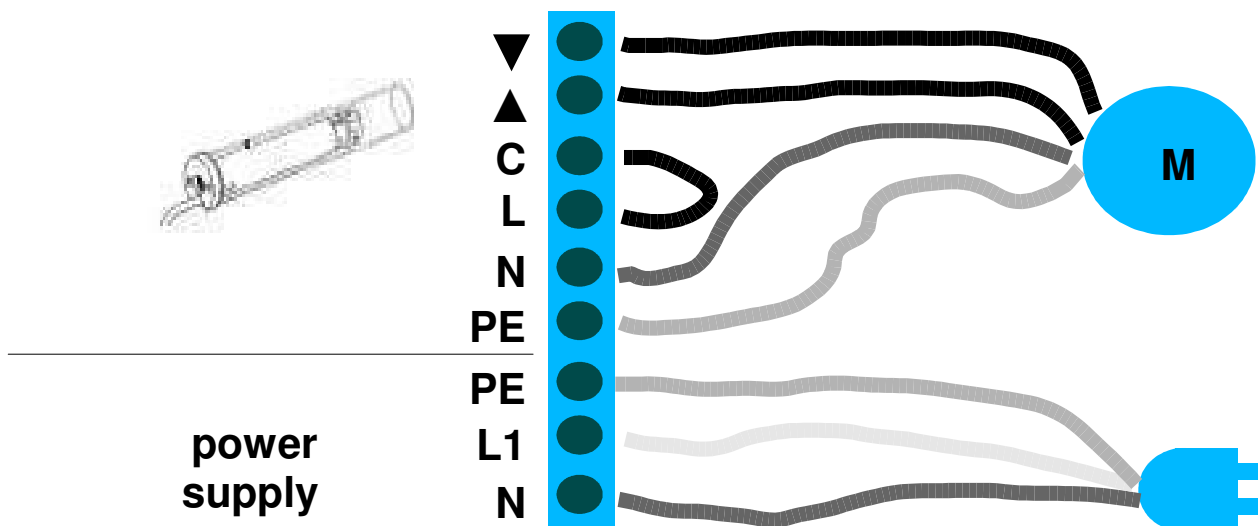

remove bridge when
installing build-in-starters

connection for build-in-starters

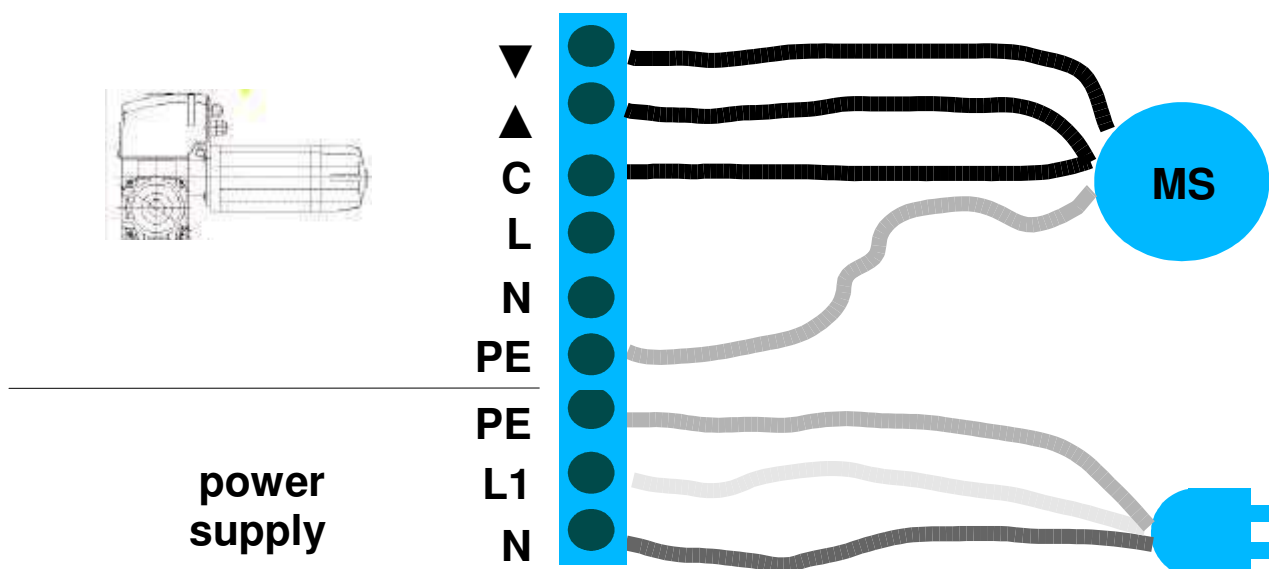

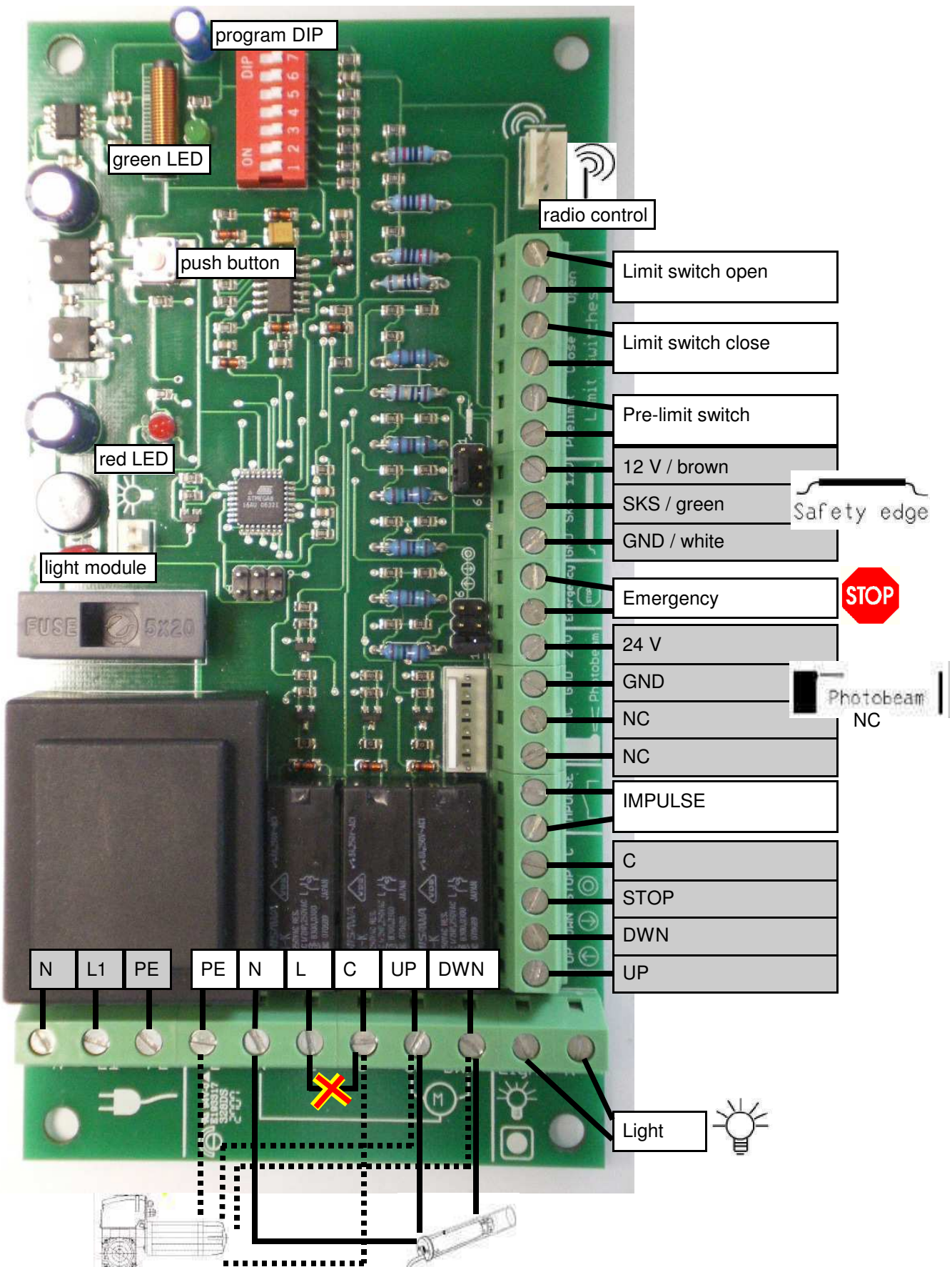

remove bridge marked with  when installing build-in-starters











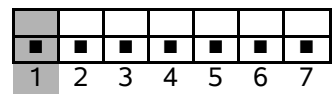
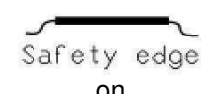
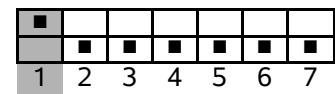
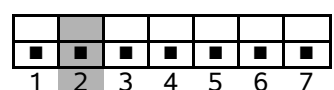

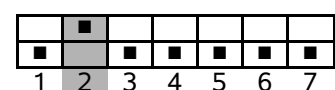

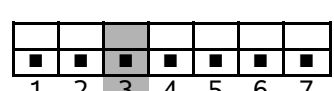

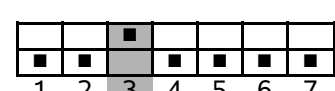

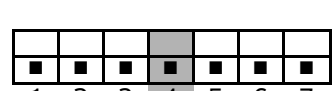
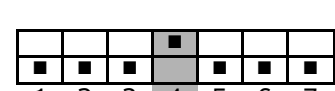
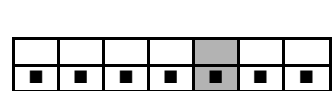
Turn power on.

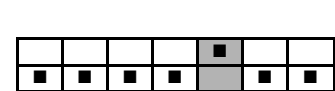
Checking

 green light on

Turn power off. 😊

Program

 <p>On Off</p>	 <p>Safety edge on</p>	 <p>On Off</p>	<p>8,2k Ω</p>
 <p>On Off</p>	<p>CT closing time off </p>	 <p>On Off</p>	<p>CT closing time on </p>
 <p>On Off</p>	<p>CT closing time 30 sec. </p>	 <p>On Off</p>	<p>CT closing time 120 sec. </p>
 <p>On Off</p>	<p>go function off</p>	 <p>On Off</p>	<p>go function active</p>
 <p>On Off</p>		 <p>On Off</p>	
 <p>On Off</p>	 <p>light prewarning in-active</p>	 <p>On Off</p>	 <p>light prewarning active</p>
 <p>On Off</p>	<p>testing in-active</p>	 <p>On Off</p>	<p>testing active</p>

Turn power on.
Ready to operate.

Radio control (maximum 20 transmitters)

1. Plug in the RC module 
for installation of the receiver module
please refer to page 26 at the bottom

2. Programming mode on
Press button >5 seconds
red LED flashes fast

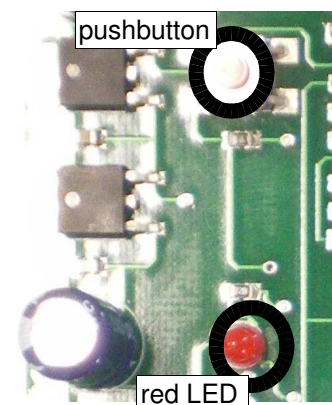

3. Programming



Press one button for two seconds
red LED flashes long once = stored
(or another type of transmitter)
and so on. Maximum 20 transmitters.

4. Programming mode off



10 seconds after the last programming the programm returns to standard mode.

5. Cancel all transmitters

Press button >5 seconds
red LED flashes fast

Press button once more for >5 seconds
red LED off = all transmitters canceled

Troubleshooting

Status red LED		Action to take	
1 x	 <p>Safety edge active</p>	1, 2, 3	
2 x	 <p>Safety edge damaged</p>	1, 2, 3, 7	
3 x	<p>Security</p> 	1, 2, 3	
4 x	RT ⌚ error	1, 2, 3	
Off	No power	1,9	
1	control installation	6	change module
2	control DIP-switch position	7	change safety edge
3	control pre-wired electrical bridges	8	change photo beam
4	control limit switches	9	change fuse
5	contact dealer	10	change the safety top barrier

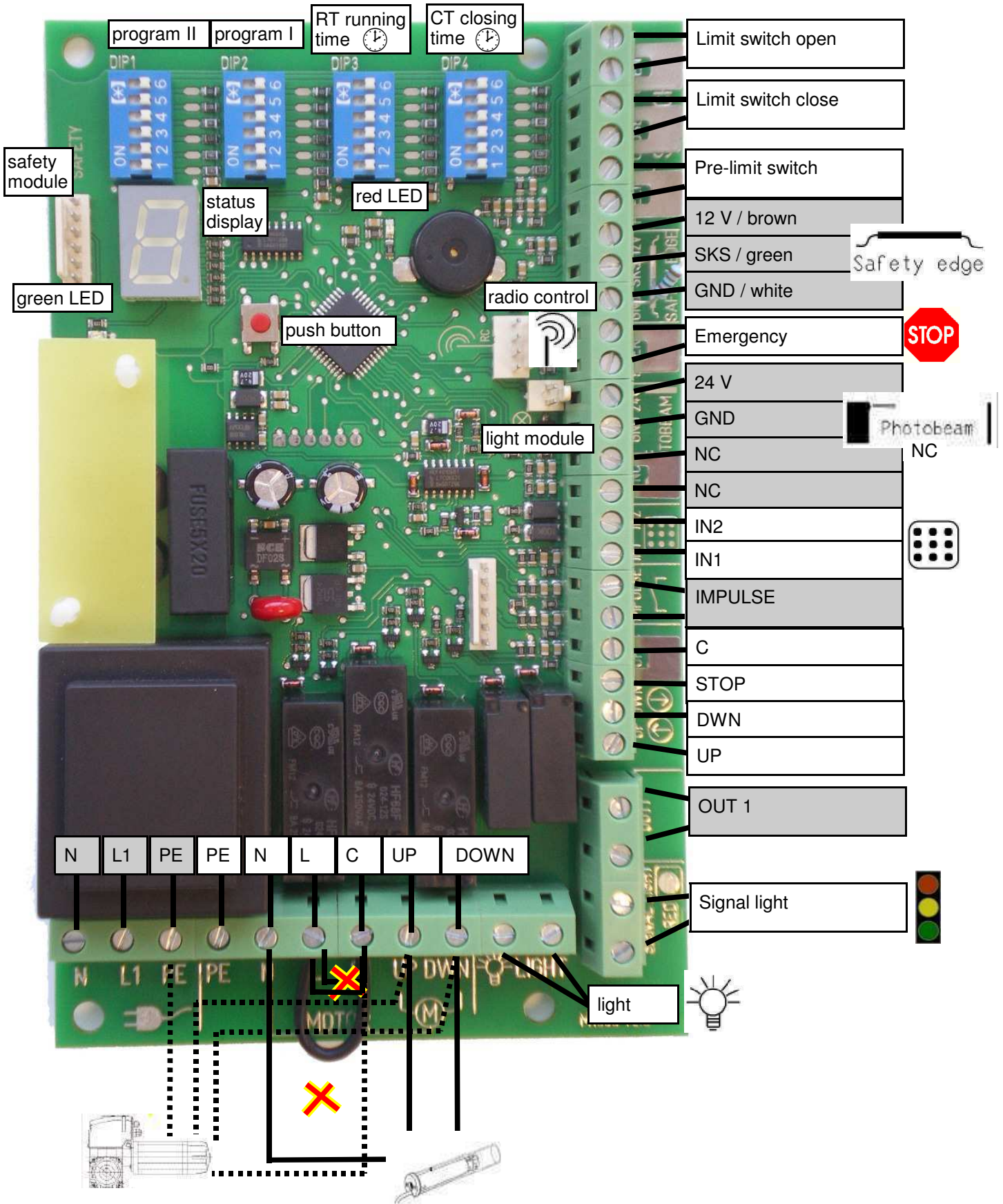

remove bridge marked with  when installing build-in-starters

Turn power on.
Checking.

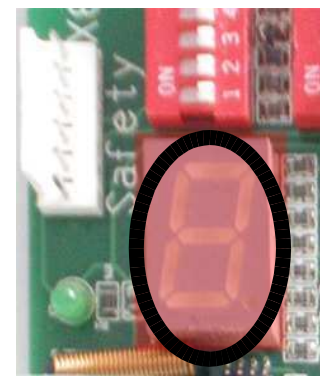

green light on 

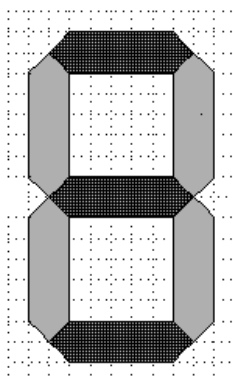

 red light off

ready to operate

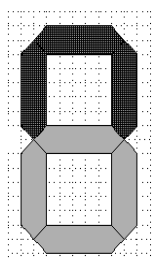

running up



door position up

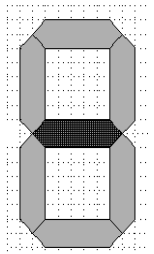
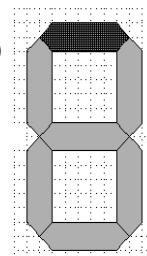

stop



middle

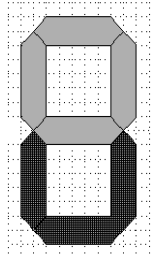
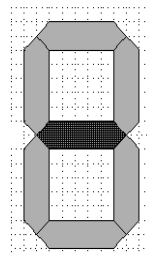

running down



door position down

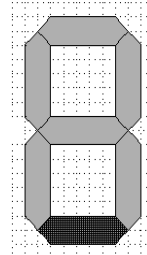

Turn power off. 😊

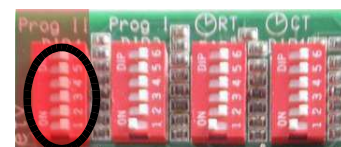

Program II

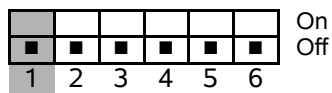

On
Off



keypad

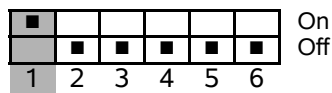

On
Off

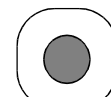

transponder

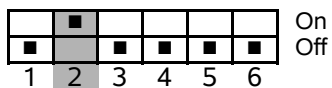

On
Off



external timer

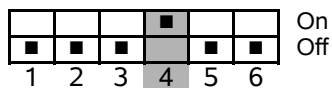

On
Off

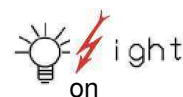

light
on

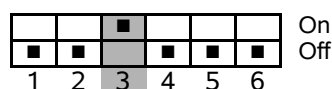

On
Off



green light

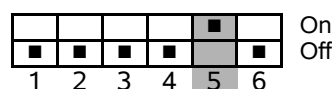

On
Off



radio control

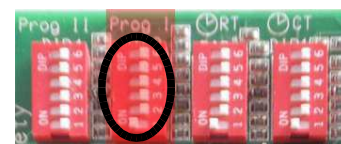

Program I

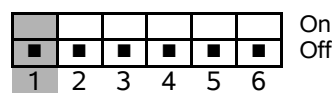

On
Off

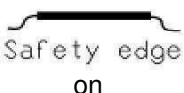

Safety edge
on

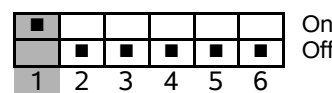

On
Off

8,2k Ω

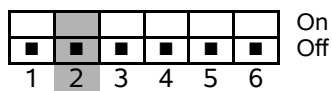

On
Off

no testing

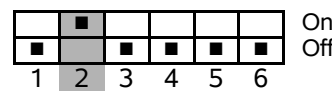

On
Off

testing active

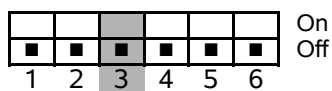

On
Off

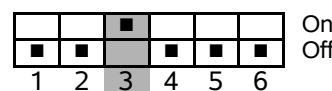
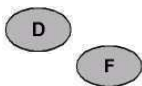

On
Off

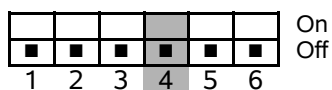

On
Off



3 sec.

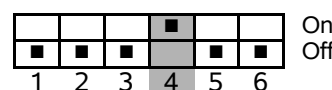

On
Off



2 min.

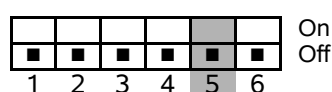

On
Off



prewarning in-active

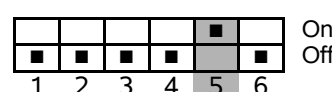

On
Off



prewarning active

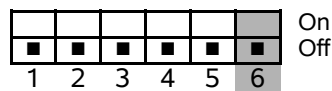

On
Off



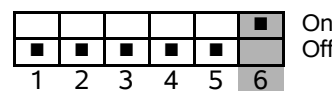





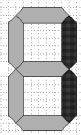

geba article
505.LS4E.OL

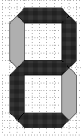

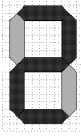
On
Off

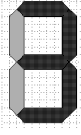

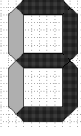
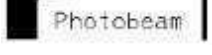
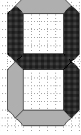
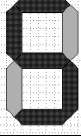
Troubleshooting

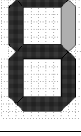
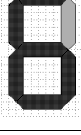
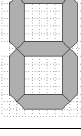
Status Display		Status red LED	Beep	Action to take
	Security 	Off	No	1, 2, 3, 4
	Safety edge active 	Off	No	1, 2, 3
	Safety edge damaged 	On	Yes	7
	Photobeam active 	Off	No	1, 2, 3
	Photobeam damaged 	On	Yes	8
	Relais damaged	On	Yes	5
	RT  error	On	Yes	1, 2, 3
	Safety top barrier active	Off	No	1, 2, 3
	Safety top barrier damaged	On	Yes	10
	No power	Off	No	1, 9
1	control installation		6	change module
2	control DIP-switch position		7	change safety edge
3	control pre-wired electrical bridges		8	change photo beam
4	control limit switches		9	change fuse
5	contact dealer		10	change the safety top barrier

Connection

Limit switch open
 Limit switch open
 Limit switch close
 Limit switch close
 Pre-limit Switch
 Pre-limit switch

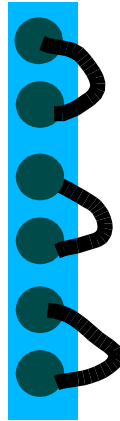

No limit switches
 (bridged!)

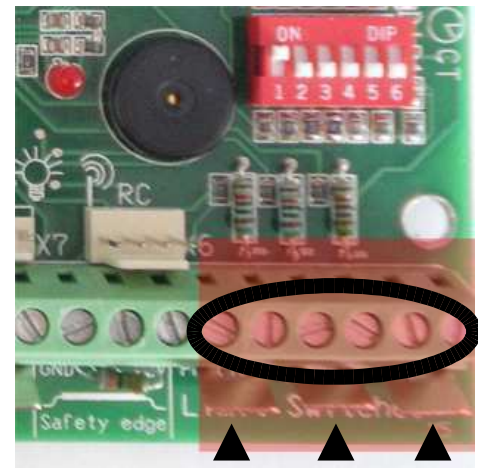
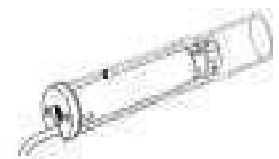

remove bridges when
 installing build-in-starters

Limit switch open
 Limit switch open
 Limit switch close
 Limit switch close
 Pre-limit Switch
 Pre-limit Switch

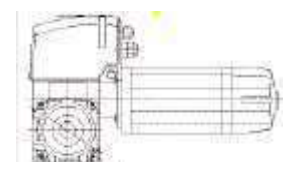
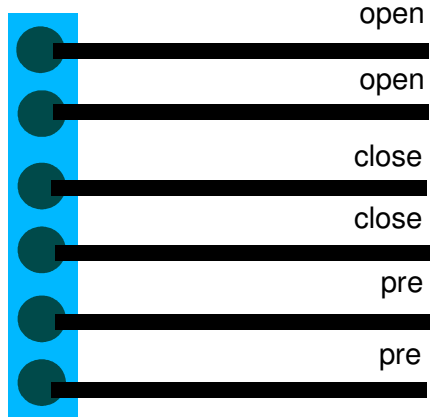

Connection accessories

KDT 3 push button

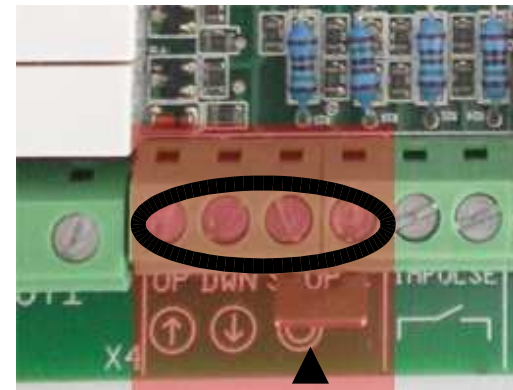
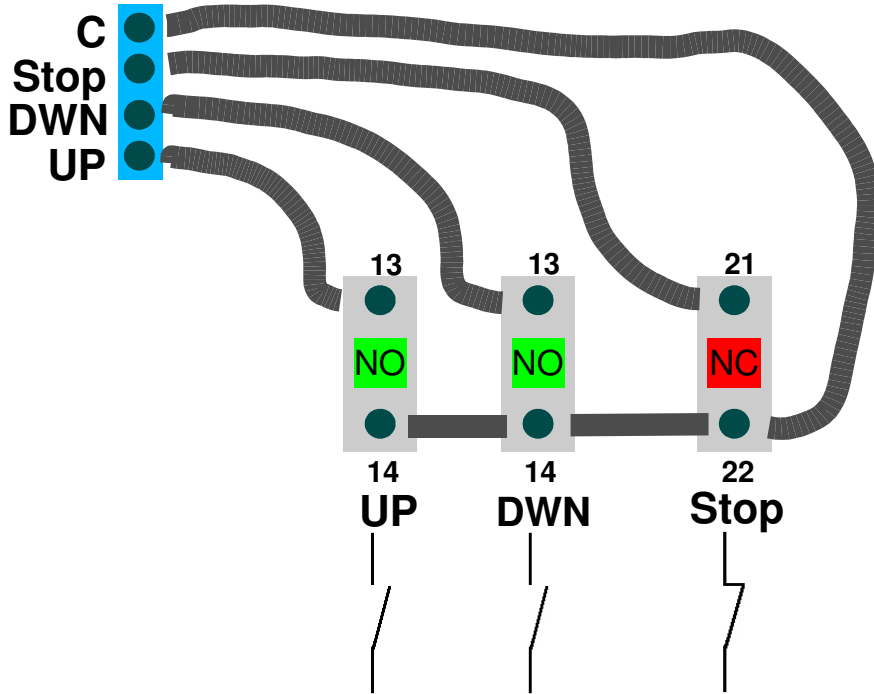

remove bridge when installing KDT 3 push button

KDT 2 push button / M Series 2T

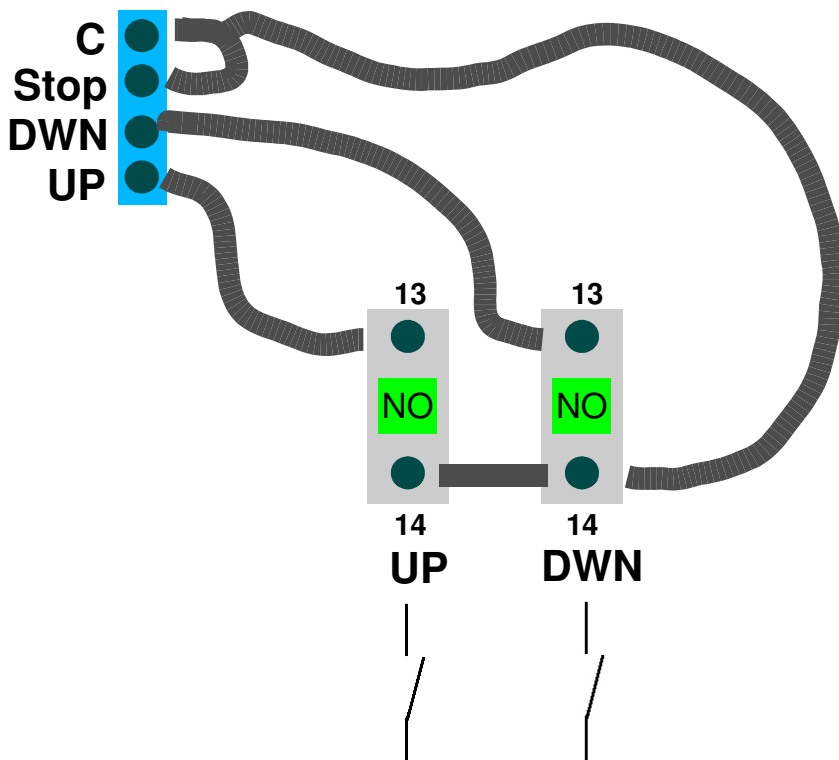

M Series 1T

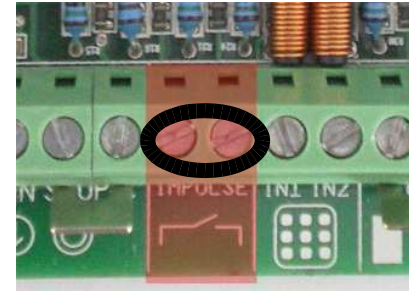
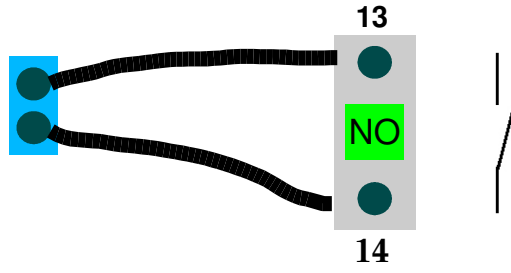

Emergency stop / KDT 1

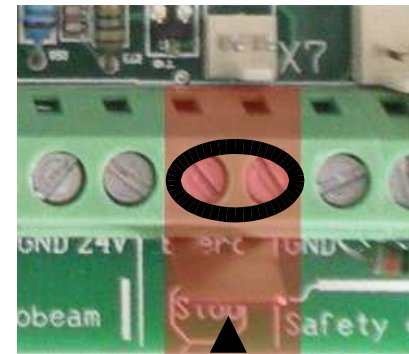
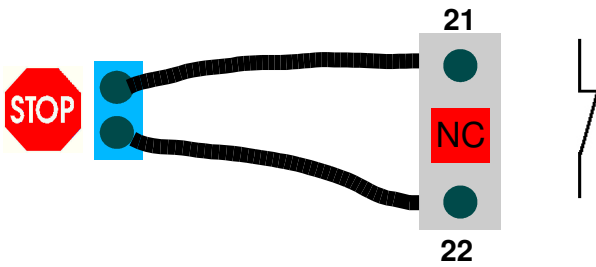

remove bridge

ES Series

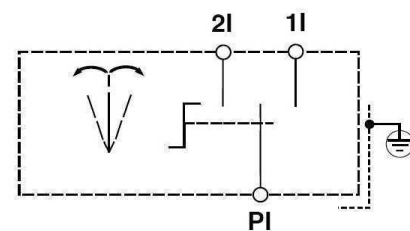
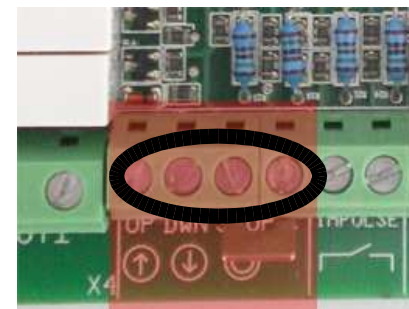
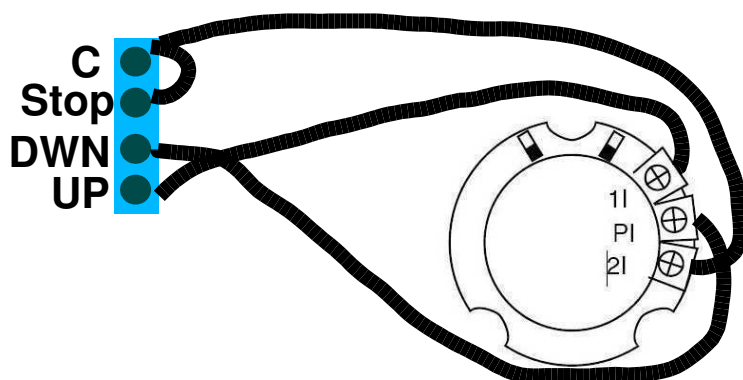

J Series

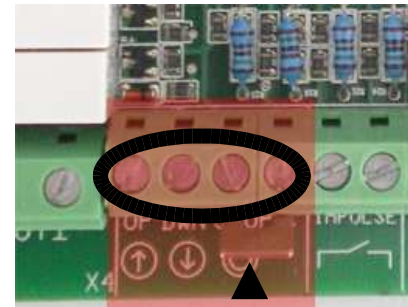
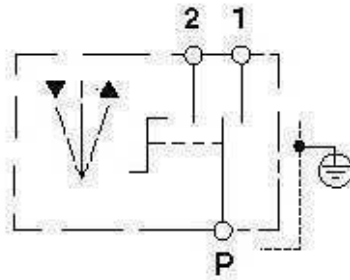
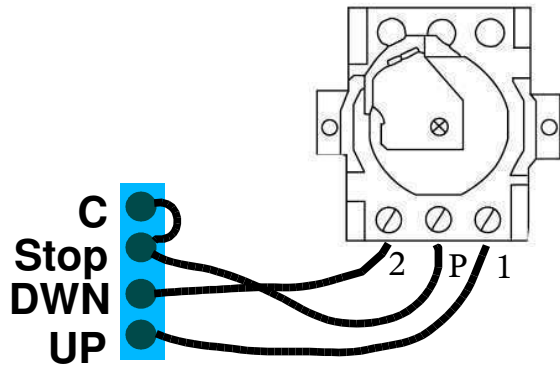

remove bridge when installing J-Series with Stop

J with Stop

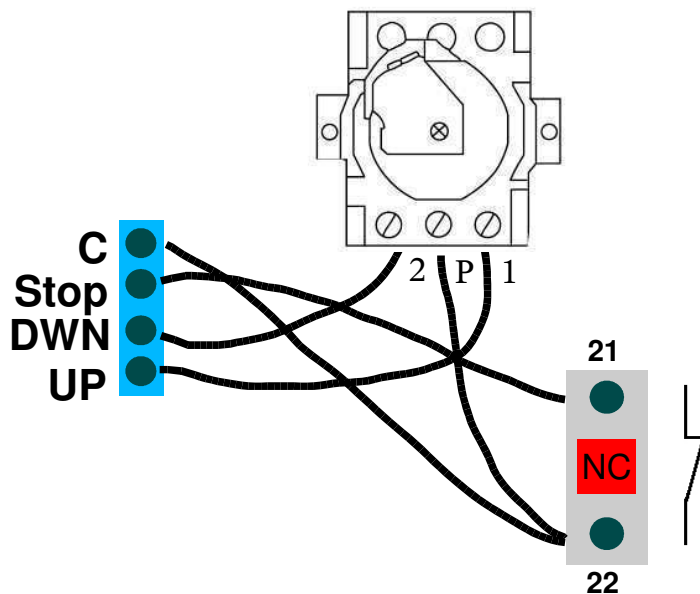
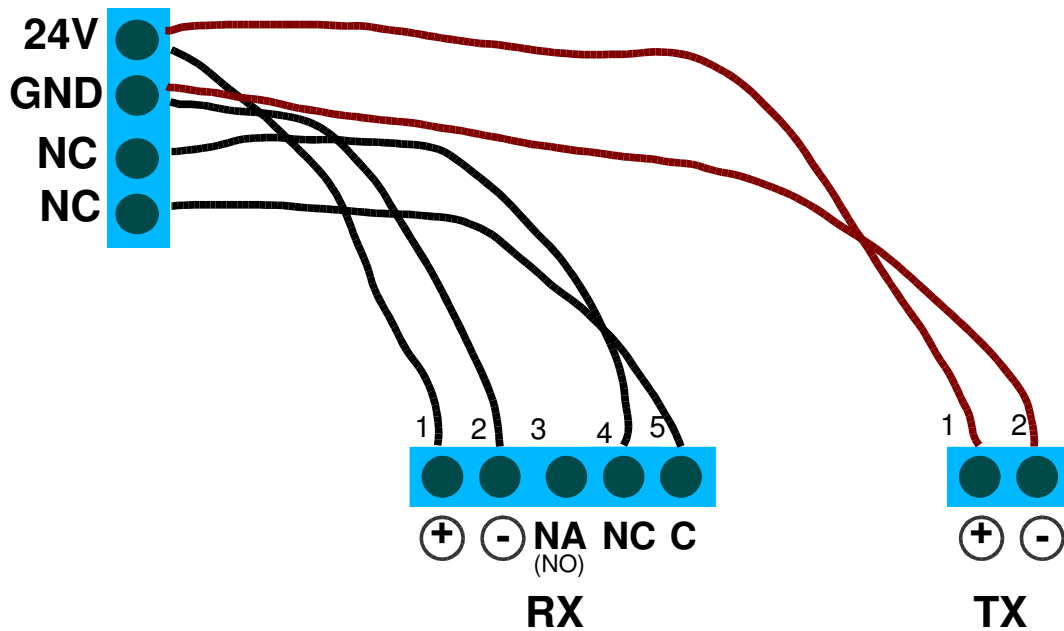
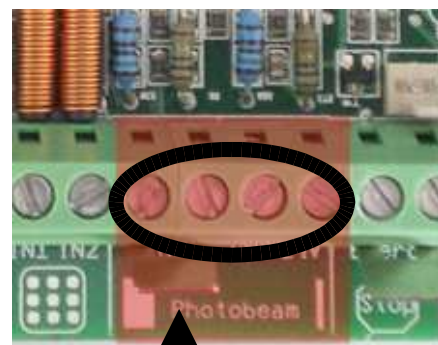
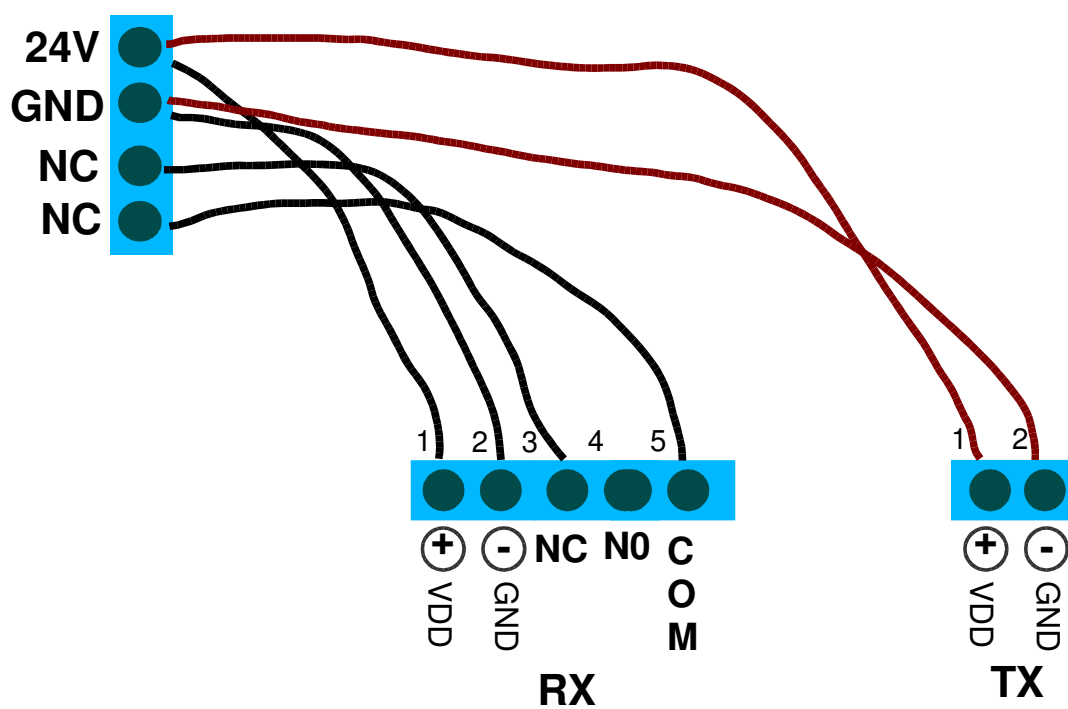

Photo beams

LS 1



LS 2



remove bridge

LS 2 reflector

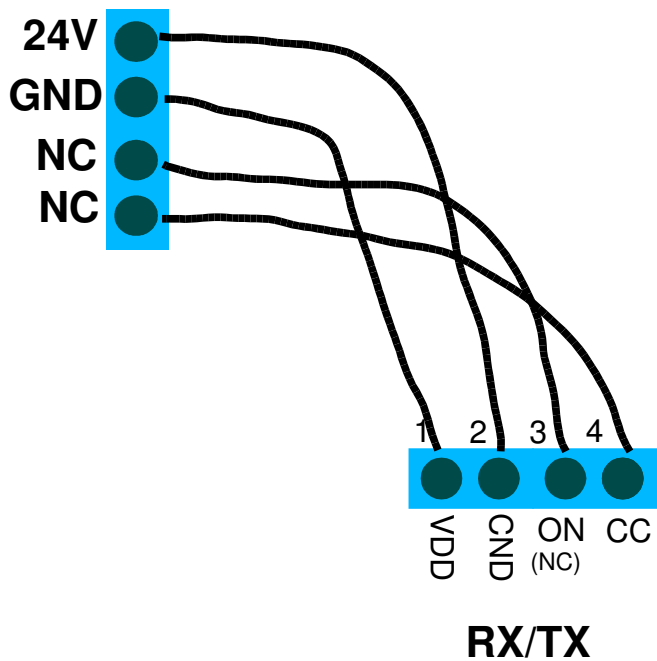

LS 3 reflector

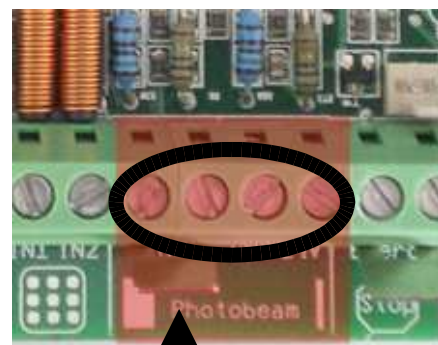
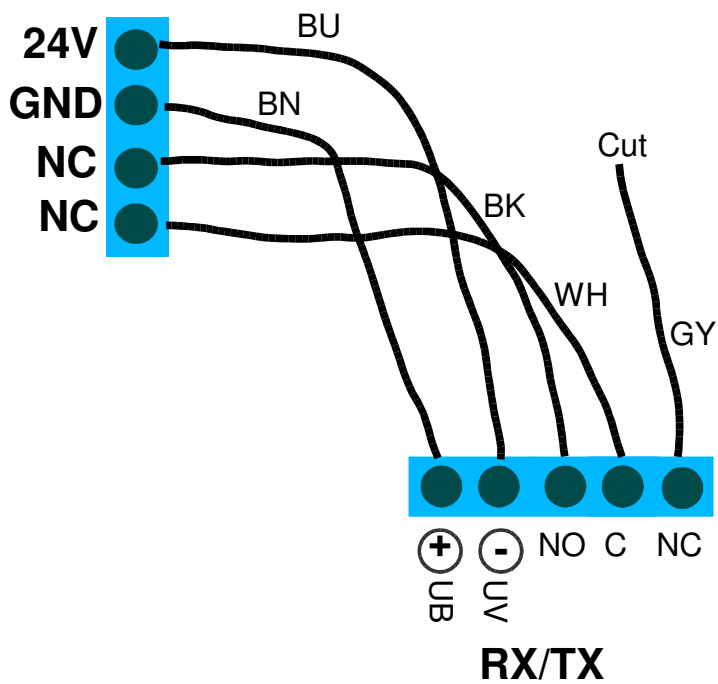

remove bridge

LS 4

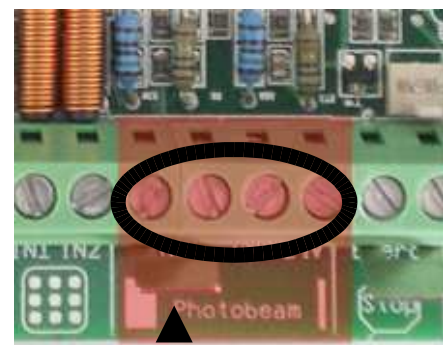
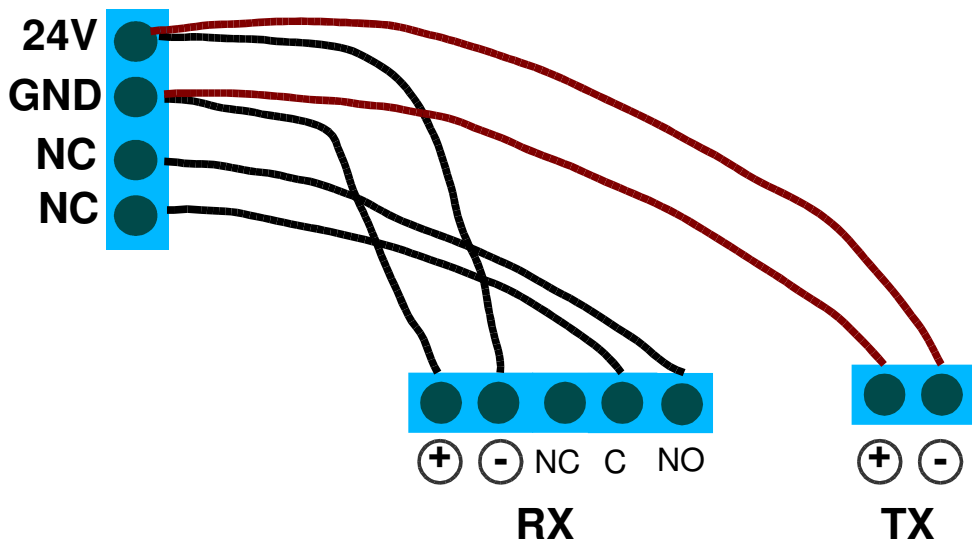

remove bridge

8,2kΩ

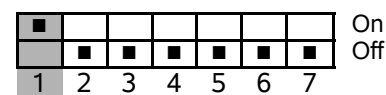
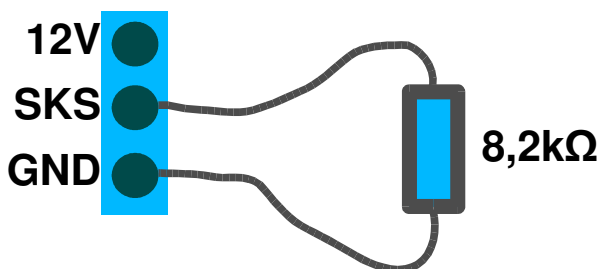

8,2kΩ

Safety edge Pro-Sec-O

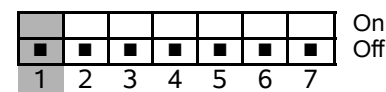
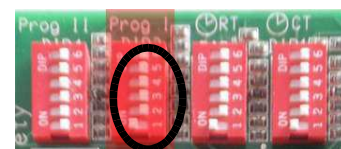
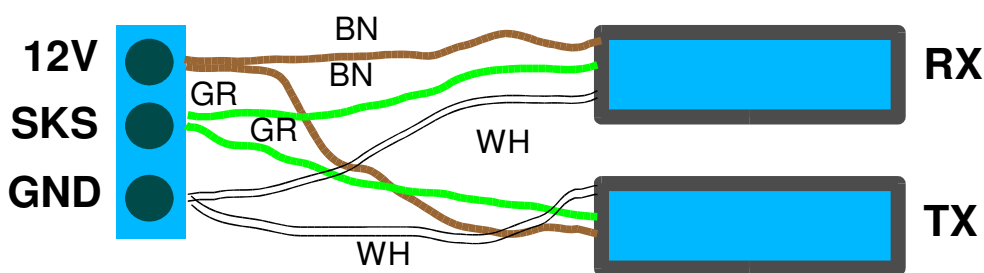

Safety edge

Court light (230 VAC) / Signal light

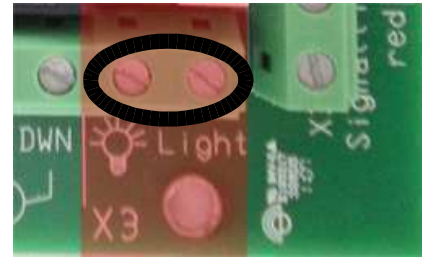
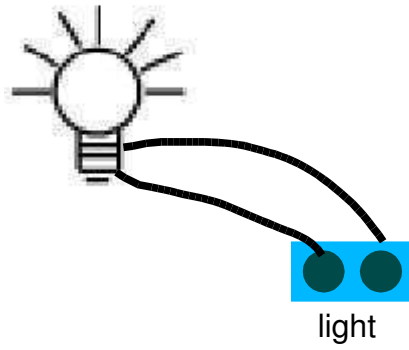

DC 2 – EURO deluxe

Signal light (230 VAC)

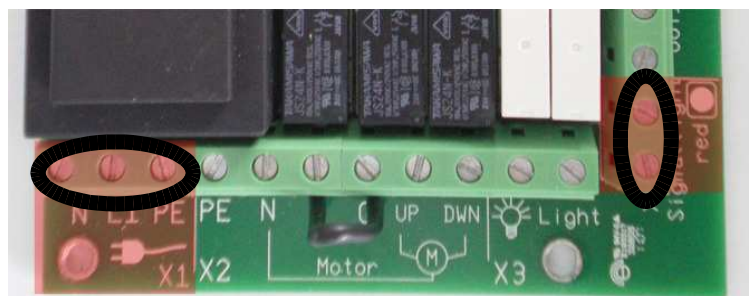
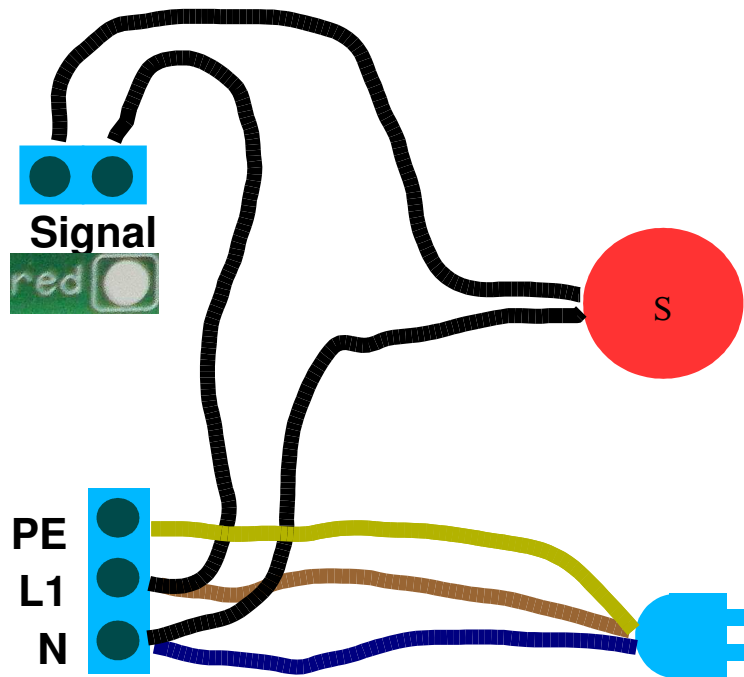

Optional accessories for DC2 deluxe

Cody

1. Wiring Keypad

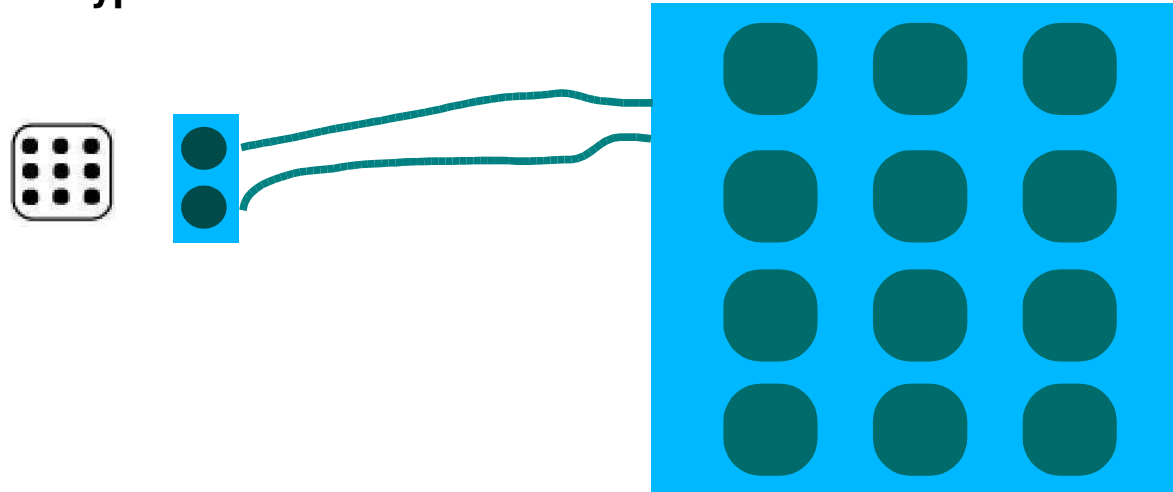
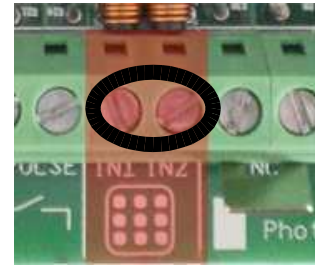

2. DIP-switch / Program 2 Programming mode on

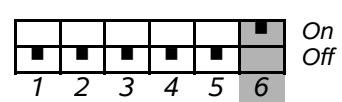

3. Insert codes (10 different codes with 4 or 5 digits) programming & operation

Insert code (e.g.)	Confirm	Status Display	Sound (beep)	buttons
1234			— — —	▲ / STOP / ▼
78541			— — —	▲ / STOP / ▼
5398			— — —	▲ / STOP / ▼
...				

4. Programming mode off

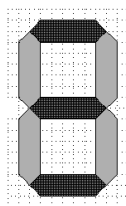
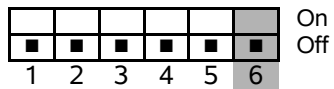

5. Cancel codes

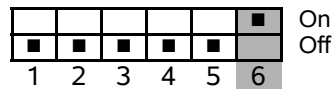

press micro push button to choose

press micro push button two seconds

code canceled / position free

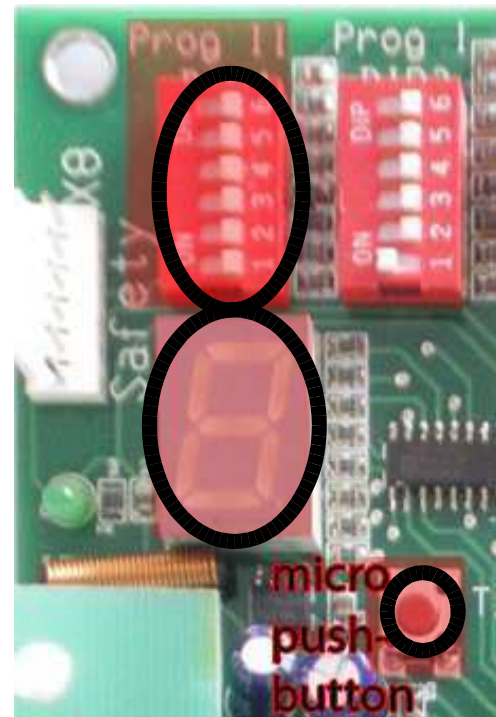
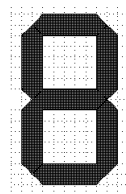

Transponder

1. Wiring



12V
SKS
GND

IN2
IN1

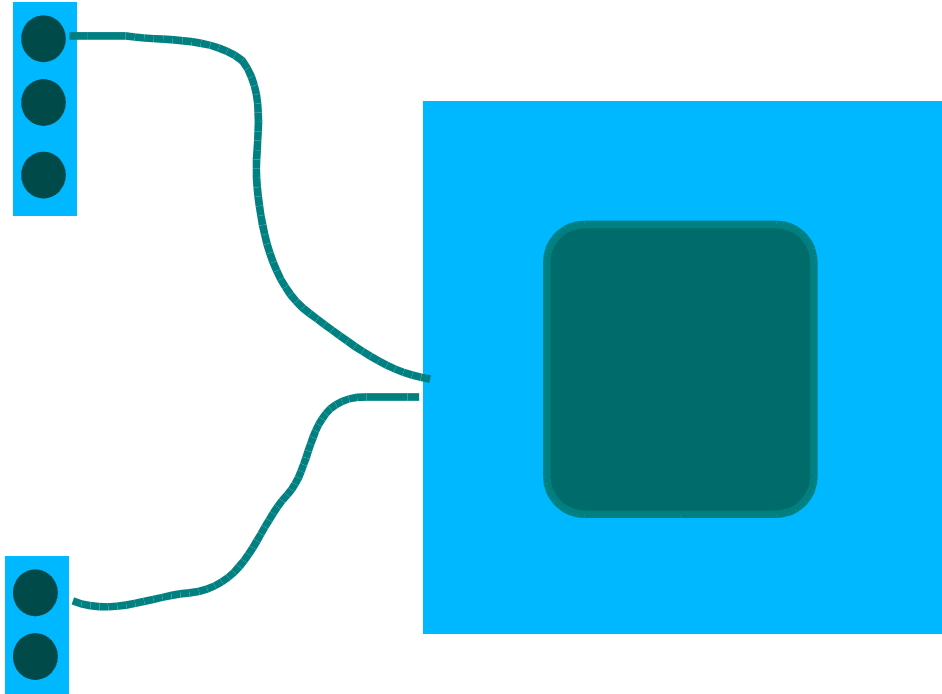

2. DIP-switch / Program 2 Programming mode on

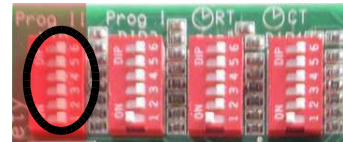
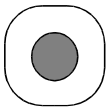
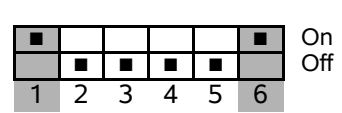

3. Programming max. 10 different keys

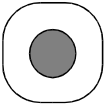
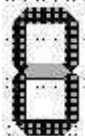
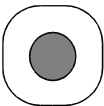
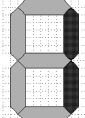
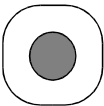
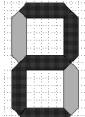
	Key No.	Position
	→ 1	
	→ 2	
	→ 3	
Maximum 10 keys		

4. Programming mode off

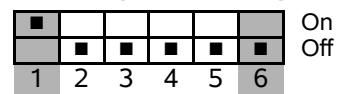

5. Cancel keys

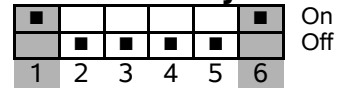

press micro push button to choose

press micro push button two seconds

key canceled / position free

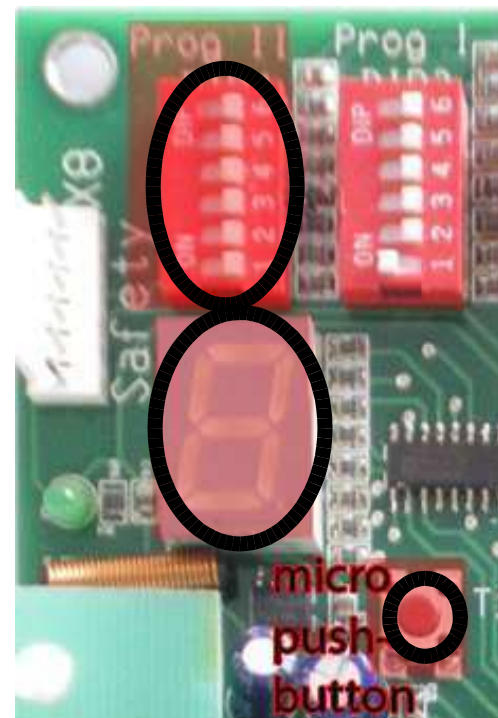
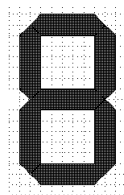

Radio control (maximum 20 transmitters)

1. Plug in the RC module  for installation of the receiver module please refer to page 26 at the bottom

2. DIP-switch / Program 2

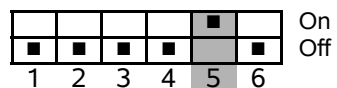

programming mode on

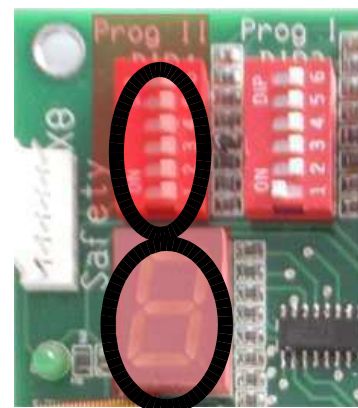

3. Programming



press one button for two seconds

(or another transmitter)

and so on. Maximum 20 transmitters.

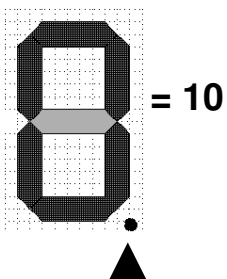
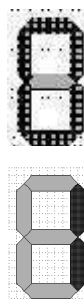

= 10

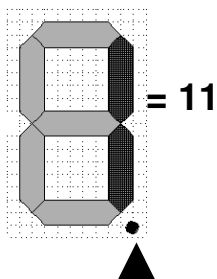

= 11

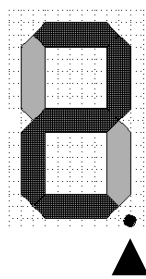

= 12 and so on.

4. Programming mode off

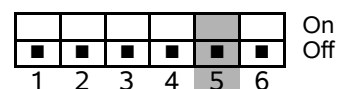

5. Cancel transmitters

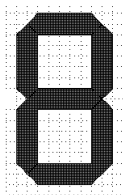
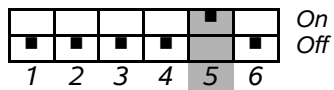

press micro push button to choose

press mirco push button two seconds

transmitter canceled / postion free

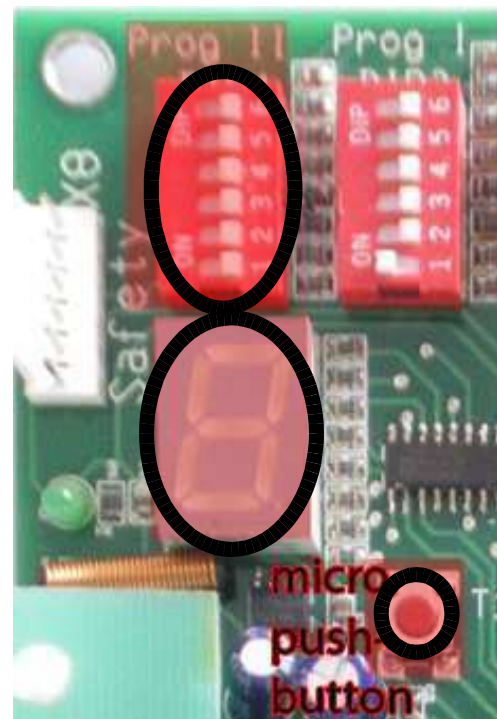

The door control DC 2 EURO is designed for hold to run control of power operated doors. The basic version is designed for hold to run operation only, and you are not allowed to use the automatic function without using additional safety devices.